

生きる

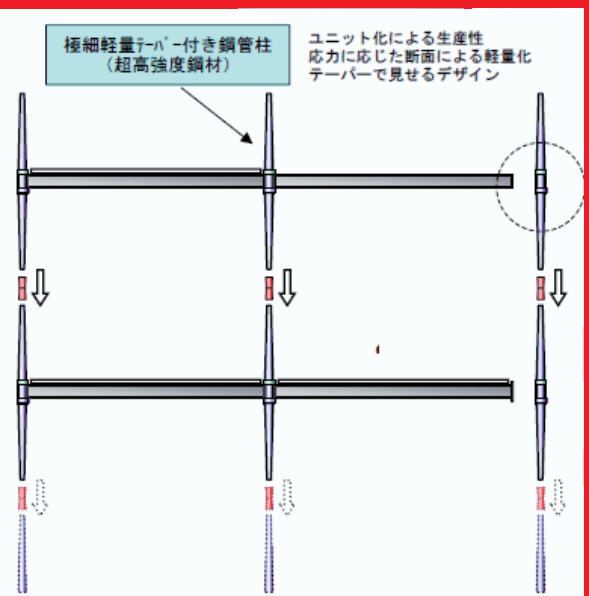

進化する

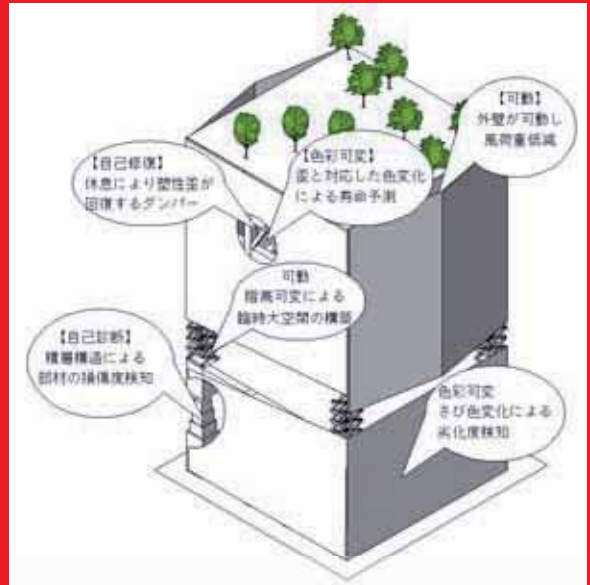

解放された

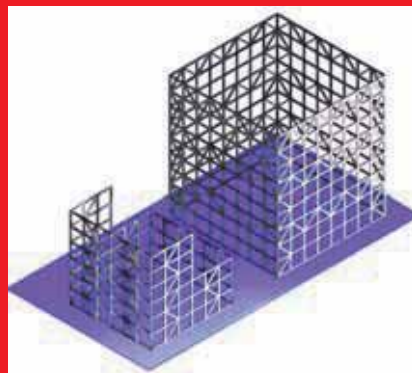

# 高性能

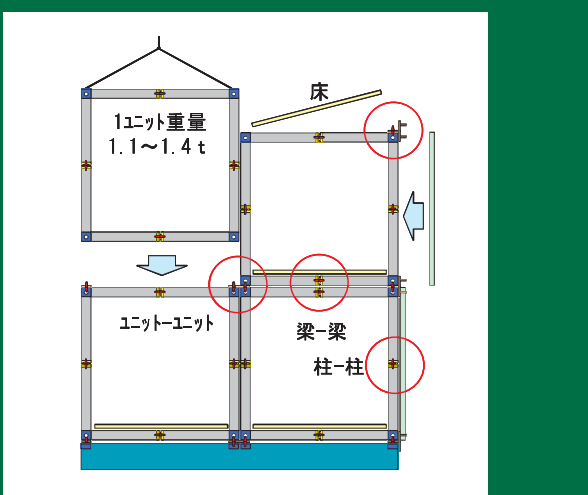
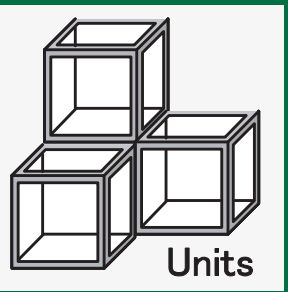
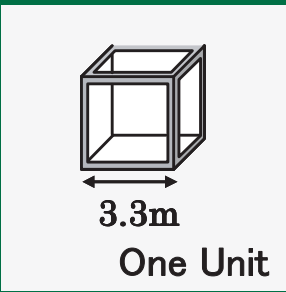
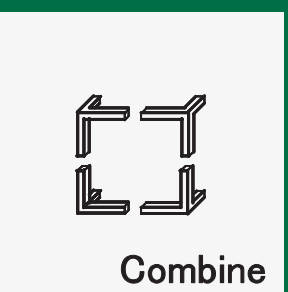
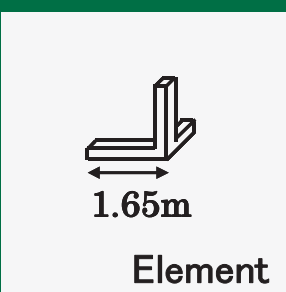
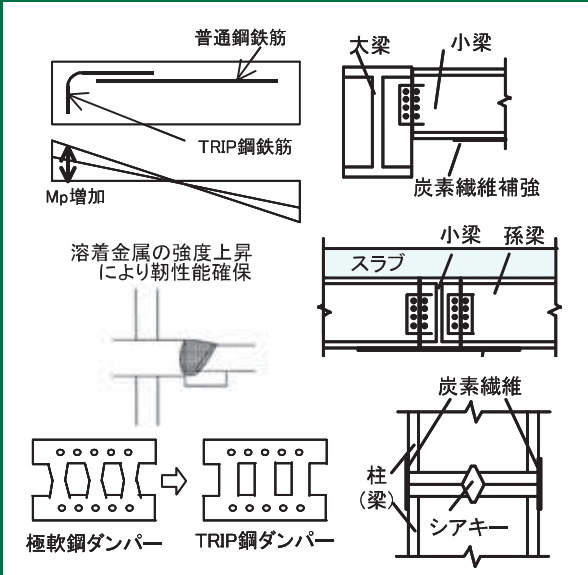
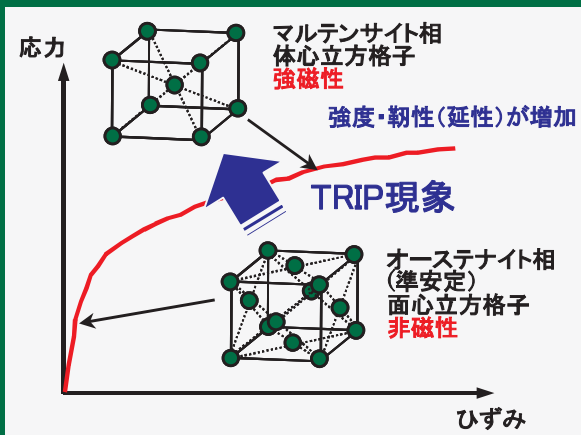

# ユニットセル

# 防災システム

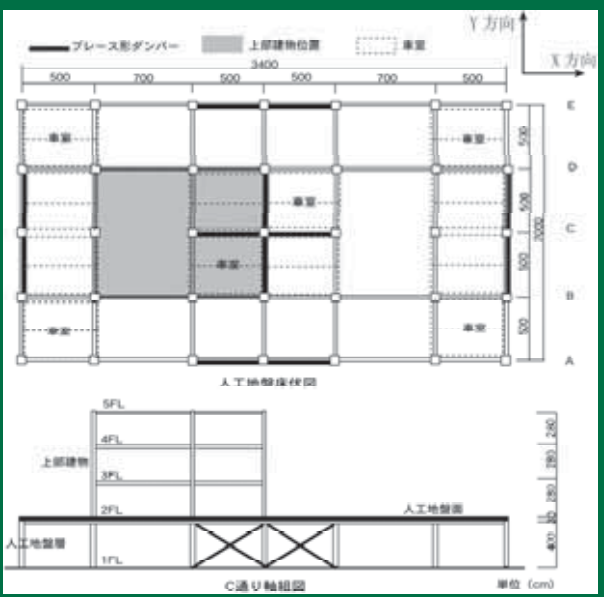

# 薄板

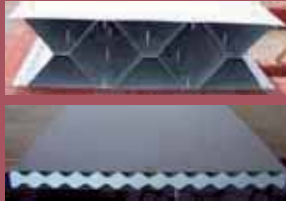
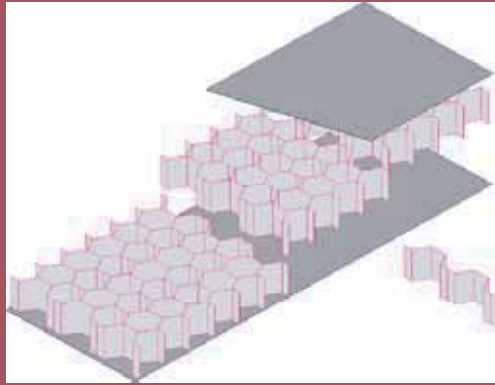

# ダンパー

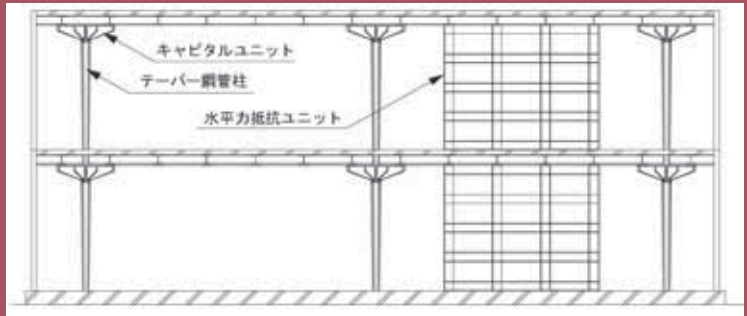
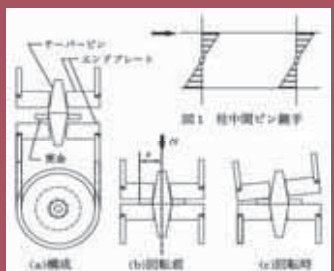
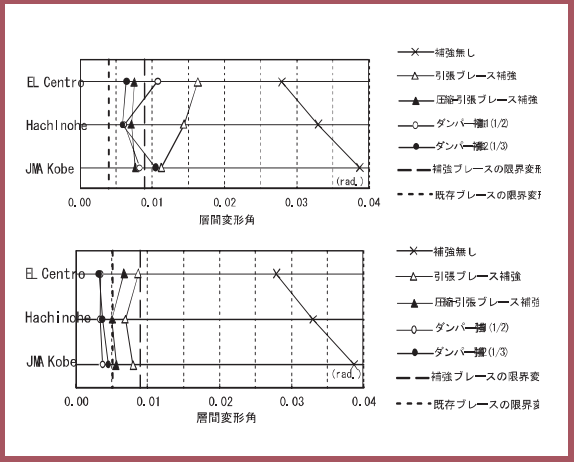

# テーパー

# 展開構造

